

# 4K HD IR Fixed Eyeball Network Camera

IPC3618LE-ADF28(40)K-G



## Key Features



- High quality image with 8MP, 1/2.7"CMOS sensor
- 8MP (3840\*2160)@20fps; 5MP (3072\*1728)@30/25fps; 4MP (2560\*1440)@30/25fps; 2MP (1920\*1080) @30/25fps
- Ultra 265, H.265, H.264, MJPEG
- EasyStar technology ensures high image quality in low illumination environment
- 120dB true WDR technology enables clear image in strong light scene
- Support 9:16 Corridor Mode
- Built-in Mic
- Smart IR, up to 30m (98ft) IR distance
- Supports 256 G Micro SD card
- IP67 protection
- Support PoE power supply
- 3-Axis

## Specifications

	IPC3618LE-ADF28K-G	IPC3618LE-ADF40K-G			
<b>Camera</b>					
Sensor	1/2.7", 8.0 megapixel, progressive scan, CMOS				
Minimum Illumination	Support EasyStar: Colour: 0.005 lux ( F1.6, AGC ON) 0Lux with IR on				
Day/Night	IR-cut filter with auto switch (ICR)				
Shutter	Auto/Manual, 1 ~ 1/100000s				
Adjustment angle	Pan: 0° ~ 360°	Tilt: 0° ~ 80°	Rotate: 0° ~ 360°		
S/N	>56dB				
WDR	120dB				
<b>Lens</b>					
Lens Type	2.8mm @F1.6	4.0mm @F1.6			
Iris	Fixed				
Field of View (H)	98.3°	91.2°			
Field of View (V)	53.3°	47.9°			
Field of View (D)	103.1°	95.9°			
<b>DORI</b>					
DORI Distance	Lens (mm)	Detect (m)	Observe (m)	Recognize (m)	Identify (m)
	2.8mm	84	33.6	16.8	8.4
	4.0mm	120	48	24	12
<b>Illuminator</b>					
IR Range	Up to 30m (98ft) IR range				
Wavelength	850nm				
IR On/Off Control	Auto/Manual				
<b>Video</b>					
Video Compression	Ultra 265, H.265, H.264, MJPEG				
H.264 code profile	Baseline profile, Main profile, High profile				
Frame Rate	Main Stream: 8MP (3840*2160), Max 20fps; 5MP (3072*1728), Max 30fps; 4MP (2560*1440), Max 30fps; 1080P (1920*1080), Max 30fps; Sub Stream: 1080P (1920*1080), Max 30fps; 720P (1280*720), Max 30fps; D1 (720*576), Max 30fps; 640*360, Max 30fps; 2CIF(704*288), Max 30fps; CIF(352*288), Max 30fps;				
Video Bit Rate	128 Kbps~16 Mbps				
U-code	Supported				
OSD	Up to 4 OSDs				
Privacy Mask	Up to 4 areas				
ROI	Up to 8 areas				
Video stream	Dual streams				
<b>Image</b>					
White Balance	Auto/Outdoor/Fine Tune/Sodium Lamp/Locked/Auto2				
Digital noise reduction	2D/3D DNR				
Smart IR	Supported				
Flip	Normal/Vertical/Horizontal/180°/90°Clockwise/90°Anti-clockwise				

HLC	Supported
BLC	Supported
Defog	Digital Defog
<b>Events</b>	
Basic Detection	Cross line, intrusion(based on human body detection),motion detection, Ultra motion detection, tampering alarm, audio detection
General Function	Watermark, IP address filtering, access policy, ARP protection, RTSP authentication, user authentication, HTTP authentication
<b>Audio</b>	
Audio Compression	G.711U, G.711A
Audio Bitrate	64 Kbps
Two-way Audio	N/A
Suppression	Support
Sampling Rate	8KHZ
<b>Storage</b>	
Edge Storage	Micro SD, up to 256 GB
Network Storage	ANR,NAS(NFS)
<b>Network</b>	
Protocols	IPv4, IPv6, IGMP, ICMP, ARP, TCP, UDP, DHCP, RTP, RTSP, RTCP, RTMP, DNS, DDNS, NTP, FTP, UPnP, HTTP, HTTPS, SMTP, SSL/TLS, 802.1x, SNMP
Compatible Integration	ONVIF (Profile S, Profile G, Profile T), API, SDK
User/Host	Up to 32 users. 2 user levels: administrator and common user
Security	Password protection, Strong password, HTTPS encryption, Export operation logs, Basic and digest authentication for RTSP, Digest authentication for HTTP, TLS 1.2, WSSE and digest authentication for ONVIF
Client	EZStation EZView EZLive
Web Browser	Plug-in required live view: IE 10 and above, Chrome 45 and above, Firefox 52 and above, Edge 79 and above
	Plug-in free live view: Chrome 57.0 and above, Firefox 58.0 and above, Edge 16 and above
<b>Interface</b>	
Audio I/O	N/A
Alarm I/O	N/A
Serial Port	N/A
Built-in Mic	Support
Built-in Speaker	N/A
WIFI	N/A
Network	1 * RJ45 10M/100M Base-TX Ethernet
Video Output	N/A
<b>Certification</b>	
EMC	CE-EMC (EN 55032: 2015+A1:2020,EN 61000-3-3: 2013+A1: 2019,EN IEC 61000-3-2: 2019+A1: 2021,EN 55035: 2017+A11:2020) FCC (FCC CFR 47 part15 B, ANSI C63.4-2014)
Safety	CE LVD (EN 62368-1:2014+A11:2017) CB (IEC 62368-1:2014) UL (UL 62368-1, 2nd Ed., Issue Date: 2014-12-01)
Environment	CE-RoHS (2011/65/EU;(EU)2015/863); WEEE (2012/19/EU); Reach (Regulation (EC) No 1907/2006)

Protection	IP67 (IEC 60529:1989+AMD1:1999+AMD2:2013)
<b>General</b>	
Power	DC 12V±25%, PoE (IEEE 802.3af)
	Power consumption: Max 4.5W
Power Interface	Ø 5.5mm coaxial power plug
Dimensions (Ø x H)	Φ118 x 95mm (Φ4.6" x 3.8")
Weight	0.36kg (0.79lb)
Working Environment	-30°C ~ 60°C (-22°F ~ 140°F), Humidity: ≤95% RH (non-condensing)
Storage Environment	-30°C ~ 60°C (-22°F ~ 140°F), Humidity: ≤95% RH (non-condensing)
Surge Protection	4KV
Reset Button	N/A

## Dimensions

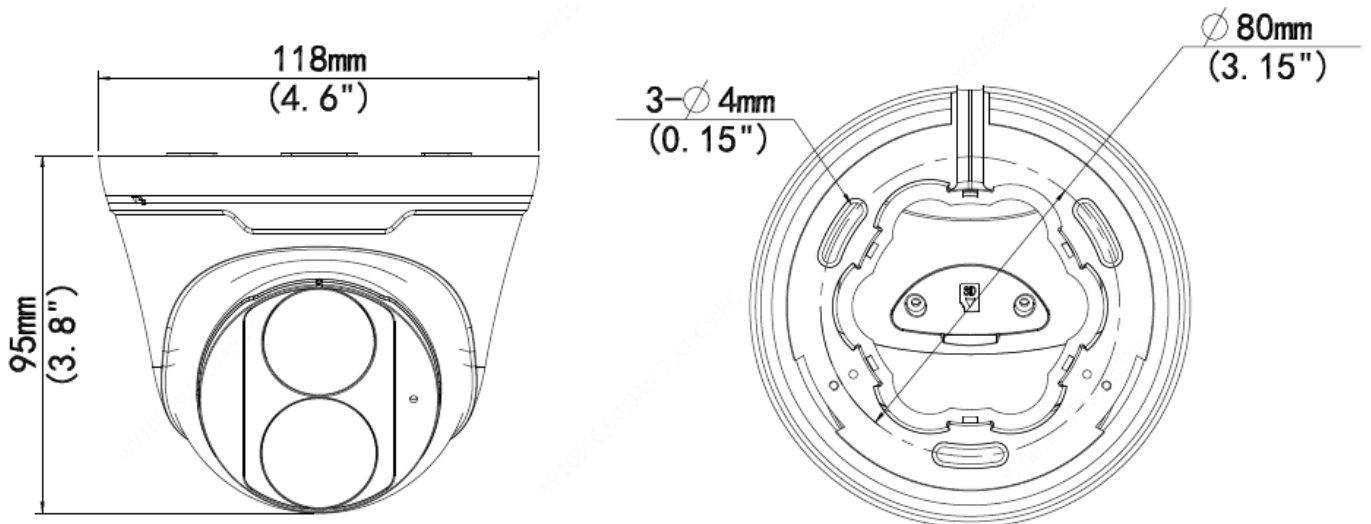

## Accessories

TR-JB03-I-IN

Junction Box



TR-UP06-IN

TR-JB07/WM03-G-IN

Wall Mount



TR-A01-IN

TR-WM03-D-IN

Wall Mount

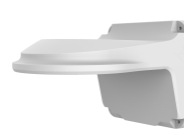

TR-SE24-IN

TR-UM06-E-IN

Incline Ceiling Mount



TR-SE24-A-IN

Pole Mount



Waterproof Joint



Pendant Mount



Pendant Mount



TR-CM24-IN

Pendant Mount

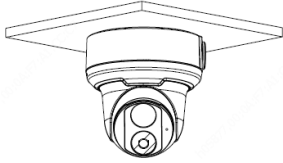
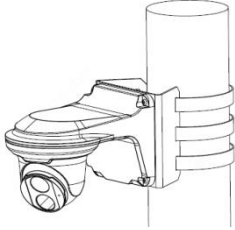
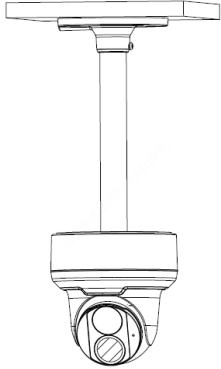

Junction Mount	Pole Mount
TR-JB03-I-IN 	TR-JB07/WM03-G-IN(TR-WM03-D-IN)+TR-UP06-IN 
TR-CM24-IN+TR-JB03-I-IN 	

**Zhejiang Uniview Technologies Co., Ltd.**

Building No.10, Wanlun Science Park, Jiangling Road 88, Binjiang District, Hangzhou, Zhejiang, China (310051)

 Email: [overseasbusiness@uniview.com](mailto:overseasbusiness@uniview.com); [globalsupport@uniview.com](mailto:globalsupport@uniview.com)
<http://www.uniview.com>

©2021-2022 Zhejiang Uniview Technologies Co., Ltd. All rights reserved.

\*Product specifications and availability are subject to change without notice.